

S-Parameter Techniques for Faster, More Accurate Network Design

ABSTRACT. Richard W. Anderson describes *s*-parameters and flowgraphs and then relates them to more familiar concepts such as transducer power gain and voltage gain. He takes swept-frequency data obtained with a network analyzer and uses it to design amplifiers. He shows how to calculate the error caused by assuming the transistor is unilateral. Both narrow band and broad band amplifier designs are discussed. Stability criteria are also considered.

This article originally appeared in the February 1967 issue of the Hewlett-Packard Journal.

LINEAR NETWORKS, OR NONLINEAR NETWORKS operating with signals sufficiently small to cause the networks to respond in a linear manner, can be completely characterized by parameters measured at the network terminals (ports) without regard to the contents of the networks. Once the parameters of a network have been determined, its behavior in any external environment can be predicted, again without regard to the specific contents of the network.

S-parameters are being used more and more in microwave design because they are easier to measure and work with at high frequencies than other kinds of parameters. They are conceptually simple, analytically convenient, and capable of providing a surprising degree of insight into a measurement or design problem. For these reasons, manufacturers of high-frequency transistors and other solid-state devices are finding it more meaningful to specify their products in terms of *s*-parameters than in any other way. How *s*-parameters can simplify microwave design problems, and how a designer can best take advantage of their abilities, are described in this article.

Two-Port Network Theory

Although a network may have any number of ports, network parameters can be explained most easily by considering a network with only two ports, an input port and an output port, like the network shown in Fig. 1. To characterize the performance of such a network, any of several parameter sets can be used, each of which has certain advantages.

Each parameter set is related to a set of four variables associated with the two-port model. Two of these variables

represent the excitation of the network (independent variables), and the remaining two represent the response of the network to the excitation (dependent variables). If the network of Fig. 1 is excited by voltage sources V_1 and V_2 , the network currents I_1 and I_2 will be related by the following equations (assuming the network behaves linearly):

$$I_1 = y_{11}V_1 + y_{12}V_2 \quad (1)$$

$$I_2 = y_{21}V_1 + y_{22}V_2 \quad (2)$$

In this case, with port voltages selected as independent variables and port currents taken as dependent variables, the relating parameters are called short-circuit admittance parameters, or *y*-parameters. In the absence of additional information, four measurements are required to determine the four parameters y_{11} , y_{21} , y_{12} , and y_{22} . Each measurement is made with one port of the network excited by a voltage source while the other port is short circuited. For example, y_{21} , the forward transadmittance, is the ratio of the current at port 2 to the voltage at port 1 with port 2 short circuited as shown in equation 3.

$$y_{21} = \left. \frac{I_2}{V_1} \right|_{V_2 = 0} \text{ (output short circuited)} \quad (3)$$

If other independent and dependent variables had been chosen, the network would have been described, as before, by two linear equations similar to equations 1 and 2, except that the variables and the parameters describing their relationships would be different. However, all parameter sets contain the same information about a network, and it is always possible to calculate any set in terms of any other set.

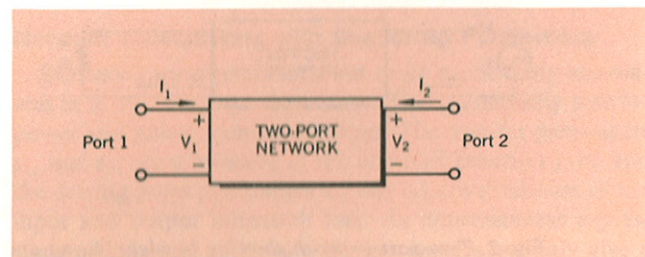

Fig. 1. General two-port network.

S-Parameters

The ease with which scattering parameters can be measured makes them especially well suited for describing transistors and other active devices. Measuring most other parameters calls for the input and output of the device to be successively opened and short circuited. This is difficult to do even at RF frequencies where lead inductance and capacitance make short and open circuits difficult to obtain. At higher frequencies these measurements typically require tuning stubs, separately adjusted at each measurement frequency, to reflect short or open circuit conditions to the device terminals. Not only is this inconvenient and tedious, but a tuning stub shunting the input or output may cause a transistor to oscillate, making the measurement difficult and invalid. S-parameters, on the other hand, are usually measured with the device imbedded between a 50Ω load and source, and there is very little chance for oscillations to occur.

Another important advantage of s-parameters stems from the fact that traveling waves, unlike terminal voltages and currents, do not vary in magnitude at points along a lossless transmission line. This means that scattering parameters can be measured on a device located at some distance from the measurement transducers, provided that the measuring device and the transducers are connected by low-loss transmission lines.

Generalized scattering parameters have been defined by K. Kurokawa.¹ These parameters describe the interrelationships of a new set of variables (a_i , b_i). The variables a_i and b_i are normalized complex voltage waves incident on and reflected from the i^{th} port of the network. They are defined in terms of the terminal voltage V_i , the terminal current I_i , and an arbitrary reference impedance Z_i , as follows

¹ K. Kurokawa, "Power Waves and the Scattering Matrix," IEEE Transactions on Microwave Theory and Techniques, Vol. MTT-13, No. 2, March, 1965.

$$a_i = \frac{V_i + Z_i I_i}{2\sqrt{\text{Re } Z_i}} \quad (4)$$

$$b_i = \frac{V_i - Z_i^* I_i}{2\sqrt{\text{Re } Z_i}} \quad (5)$$

where the asterisk denotes the complex conjugate.

For most measurements and calculations it is convenient to assume that the reference impedance Z_i is positive and real. For the remainder of this article, then, all variables and parameters will be referenced to a single positive real impedance Z_0 .

The wave functions used to define s-parameters for a two-port network are shown in Fig. 2. The independent variables a_1 and a_2 are normalized incident voltages, as follows:

$$a_1 = \frac{V_1 + I_1 Z_0}{2\sqrt{Z_0}} = \frac{\text{voltage wave incident on port 1}}{\sqrt{Z_0}} = \frac{V_{i1}}{\sqrt{Z_0}} \quad (6)$$

$$a_2 = \frac{V_2 + I_2 Z_0}{2\sqrt{Z_0}} = \frac{\text{voltage wave incident on port 2}}{\sqrt{Z_0}} = \frac{V_{i2}}{\sqrt{Z_0}} \quad (7)$$

Dependent variables b_1 and b_2 are normalized reflected voltages:

$$b_1 = \frac{V_1 - I_1 Z_0}{2\sqrt{Z_0}} = \frac{\text{voltage wave reflected (or emanating) from port 1}}{\sqrt{Z_0}} = \frac{V_{r1}}{\sqrt{Z_0}} \quad (8)$$

$$b_2 = \frac{V_2 - I_2 Z_0}{2\sqrt{Z_0}} = \frac{\text{voltage wave reflected (or emanating) from port 2}}{\sqrt{Z_0}} = \frac{V_{r2}}{\sqrt{Z_0}} \quad (9)$$

The linear equations describing the two-port network are then:

$$b_1 = s_{11}a_1 + s_{12}a_2 \quad (10)$$

$$b_2 = s_{21}a_1 + s_{22}a_2 \quad (11)$$

The s-parameters s_{11} , s_{22} , s_{21} , and s_{12} are:

$$s_{11} = \left. \frac{b_1}{a_1} \right|_{a_2=0} = \text{Input reflection coefficient with the output port terminated by a matched load } (Z_L = Z_0 \text{ sets } a_2 = 0). \quad (12)$$

$$s_{22} = \left. \frac{b_2}{a_2} \right|_{a_1=0} = \text{Output reflection coefficient with the input terminated by a matched load } (Z_S = Z_0 \text{ and } V_S = 0). \quad (13)$$

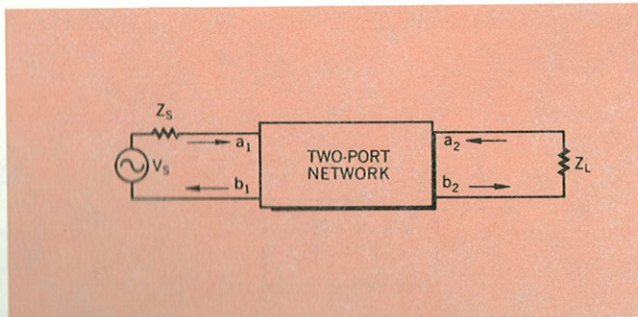

Fig. 2. Two-port network showing incident (a_1 , a_2) and reflected (b_1 , b_2) waves used in s-parameter definitions.

$$s_{21} = \left. \frac{b_2}{a_1} \right|_{a_2=0} = \text{Forward transmission (insertion) gain with the output port terminated in a matched load.} \quad (14)$$

$$s_{12} = \left. \frac{b_1}{a_2} \right|_{a_1=0} = \text{Reverse transmission (insertion) gain with the input port terminated in a matched load.} \quad (15)$$

Notice that

$$s_{11} = \frac{b_1}{a_1} = \frac{\frac{V_1}{I_1} - Z_0}{\frac{V_1}{I_1} + Z_0} = \frac{Z_1 - Z_0}{Z_1 + Z_0} \quad (16)$$

$$\text{and} \quad Z_1 = Z_0 \frac{(1 + s_{11})}{(1 - s_{11})} \quad (17)$$

where $Z_1 = \frac{V_1}{I_1}$ is the input impedance at port 1.

This relationship between reflection coefficient and impedance is the basis of the Smith Chart transmission-line calculator. Consequently, the reflection coefficients s_{11} and s_{22} can be plotted on Smith charts, converted directly to impedance, and easily manipulated to determine matching networks for optimizing a circuit design.

The above equations show one of the important advantages of s-parameters, namely that they are simply gains and reflection coefficients, both familiar quantities to engineers. By comparison, some of the y-parameters described earlier in this article are not so familiar. For example, the y-parameter corresponding to insertion gain s_{21} is the 'forward transadmittance' y_{21} given by equation 3. Clearly, insertion gain gives by far the greater insight into the operation of the network.

Another advantage of s-parameters springs from the simple relationships between the variables a_1 , a_2 , b_1 , and b_2 , and various power waves:

$$|a_1|^2 = \text{Power incident on the input of the network.} \\ = \text{Power available from a source of impedance } Z_0.$$

$$|a_2|^2 = \text{Power incident on the output of the network.} \\ = \text{Power reflected from the load.}$$

$$|b_1|^2 = \text{Power reflected from the input port of the network.} \\ = \text{Power available from a } Z_0 \text{ source minus the power delivered to the input of the network.}$$

$$|b_2|^2 = \text{Power reflected or emanating from the output of the network.} \\ = \text{Power incident on the load.} \\ = \text{Power that would be delivered to a } Z_0 \text{ load.}$$

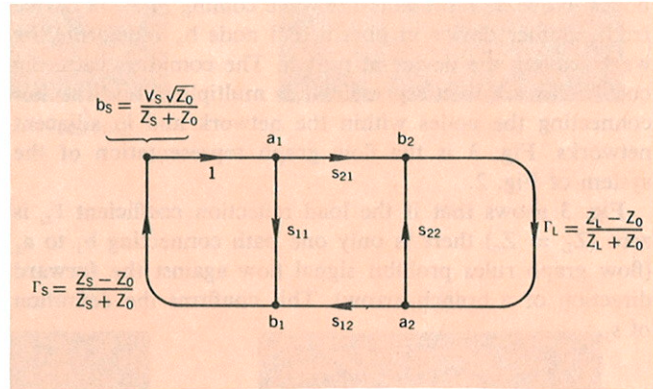

Fig. 3. Flow graph of network of Fig. 2.

Hence s-parameters are simply related to power gain and mismatch loss, quantities which are often of more interest than the corresponding voltage functions:

$$|s_{11}|^2 = \frac{\text{Power reflected from the network input}}{\text{Power incident on the network input}}$$

$$|s_{22}|^2 = \frac{\text{Power reflected from the network output}}{\text{Power incident on the network output}}$$

$$|s_{21}|^2 = \frac{\text{Power delivered to a } Z_0 \text{ load}}{\text{Power available from } Z_0 \text{ source}} \\ = \text{Transducer power gain with } Z_0 \text{ load and source}$$

$$|s_{12}|^2 = \text{Reverse transducer power gain with } Z_0 \text{ load and source.}$$

Network Calculations with Scattering Parameters

Scattering parameters turn out to be particularly convenient in many network calculations. This is especially true for power and power gain calculations. The transfer parameters s_{12} and s_{21} are a measure of the complex insertion gain, and the driving point parameters s_{11} and s_{22} are a measure of the input and output mismatch loss. As dimensionless expressions of gain and reflection, the parameters not only give a clear and meaningful physical interpretation of the network

performance but also form a natural set of parameters for use with signal flow graphs^{2,3}. Of course, it is not necessary to use signal flow graphs in order to use s-parameters, but flow graphs make s-parameter calculations extremely simple, and I recommend them very strongly. Flow graphs will be used in the examples that follow.

In a signal flow graph each port is represented by two nodes. Node a_n represents the wave coming into the device from another device at port n and node b_n represents the wave leaving the device at port n . The complex scattering coefficients are then represented as multipliers on branches connecting the nodes within the network and in adjacent networks. Fig. 3 is the flow graph representation of the system of Fig. 2.

Fig. 3 shows that if the load reflection coefficient Γ_L is zero ($Z_L = Z_0$) there is only one path connecting b_1 to a_1 (flow graph rules prohibit signal flow against the forward direction of a branch arrow). This confirms the definition of s_{11} :

$$s_{11} = \frac{b_1}{a_1} \Big|_{a_2 = \Gamma_L b_2 = 0}$$

The simplification of network analysis by flow graphs results from the application of the "non-touching loop rule." This rule applies a generalized formula to determine the transfer function between any two nodes within a complex system. The non-touching loop rule is explained in footnote 4.

² J. K. Hunton, 'Analysis of Microwave Measurement Techniques by Means of Signal Flow Graphs,' IRE Transactions on Microwave Theory and Techniques, Vol. MTT-8, No. 2, March, 1960.

³ N. Kuhn, 'Simplified Signal Flow Graph Analysis,' Microwave Journal, Vol. 6, No. 11, Nov., 1963.

⁴ The nontouching loop rule provides a simple method for writing the solution of any flow graph by inspection. The solution T (the ratio of the output variable to the input variable) is

$$T = \frac{\sum_k T_k \Delta_k}{\Delta}$$

where T_k = path gain of the k^{th} forward path

$\Delta = 1 -$ (sum of all individual loop gains) + (sum of the loop gain products of all possible combinations of two nontouching loops) - (sum of the loop gain products of all possible combinations of three nontouching loops) +

Δ_k = The value of Δ not touching the k^{th} forward path.

A path is a continuous succession of branches, and a forward path is a path connecting the input node to the output node, where no node is encountered more than once. Path gain is the product of all the branch multipliers along the path. A loop is a path which originates and terminates on the same node, no node being encountered more than once. Loop gain is the product of the branch multipliers around the loop.

For example, in Fig. 3 there is only one forward path from b_2 to b_1 and its gain is s_{11} . There are two paths from b_2 to b_1 ; their path gains are $s_{11}s_{12}\Gamma_L$ and s_{11} , respectively. There are three individual loops, only one combination of two nontouching loops, and no combinations of three or more nontouching loops; therefore, the value of Δ for this network is

$$\Delta = 1 - (s_{11}\Gamma_L + s_{11}s_{12}\Gamma_L\Gamma_S + s_{22}\Gamma_L) + (s_{11}s_{22}\Gamma_L\Gamma_S)$$

The transfer function from b_2 to b_1 is therefore

$$\frac{b_1}{b_2} = \frac{s_{11}}{\Delta}$$

Using scattering parameter flow-graphs and the non-touching loop rule, it is easy to calculate the transducer power gain with arbitrary load and source. In the following equations the load and source are described by their reflection coefficients Γ_L and Γ_S , respectively, referenced to the real characteristic impedance Z_0 .

Transducer power gain

$$G_T = \frac{\text{Power delivered to the load}}{\text{Power available from the source}} = \frac{P_L}{P_{avs}}$$

$$P_L = P(\text{incident on load}) - P(\text{reflected from load}) \\ = |b_2|^2 (1 - |\Gamma_L|^2)$$

$$P_{avs} = \frac{|b_s|^2}{(1 - |\Gamma_S|^2)}$$

$$G_T = \left| \frac{b_2}{b_s} \right|^2 (1 - |\Gamma_S|^2) (1 - |\Gamma_L|^2)$$

Using the non-touching loop rule,

$$\frac{b_2}{b_s} = \frac{s_{21}}{1 - s_{11}\Gamma_S - s_{22}\Gamma_L - s_{21}s_{12}\Gamma_L\Gamma_S + s_{11}\Gamma_S s_{22}\Gamma_L} \\ = \frac{s_{21}}{(1 - s_{11}\Gamma_S)(1 - s_{22}\Gamma_L) - s_{21}s_{12}\Gamma_L\Gamma_S} \\ G_T = \frac{|s_{21}|^2 (1 - |\Gamma_S|^2) (1 - |\Gamma_L|^2)}{|(1 - s_{11}\Gamma_S)(1 - s_{22}\Gamma_L) - s_{21}s_{12}\Gamma_L\Gamma_S|^2} \quad (18)$$

Two other parameters of interest are:

1) Input reflection coefficient with the output termination arbitrary and $Z_S = Z_0$.

$$s'_{11} = \frac{b_1}{a_1} = \frac{s_{11}(1 - s_{22}\Gamma_L) + s_{21}s_{12}\Gamma_L}{1 - s_{22}\Gamma_L} \\ = s_{11} + \frac{s_{21}s_{12}\Gamma_L}{1 - s_{22}\Gamma_L} \quad (19)$$

2) Voltage gain with arbitrary source and load impedances

$$A_V = \frac{V_2}{V_1} \quad V_1 = (a_1 + b_1) \sqrt{Z_0} = V_{11} + V_{r1} \\ V_2 = (a_2 + b_2) \sqrt{Z_0} = V_{12} + V_{r2} \\ a_2 = \Gamma_L b_2 \\ b_1 = s'_{11} a_1 \\ A_V = \frac{b_2(1 + \Gamma_L)}{a_1(1 + s'_{11})} = \frac{s_{21}(1 + \Gamma_L)}{(1 - s_{22}\Gamma_L)(1 + s'_{11})} \quad (20)$$

On p. 11 is a table of formulas for calculating many often-used network functions (power gains, driving point characteristics, etc.) in terms of scattering parameters. Also included in the table are conversion formulas between s-parameters and h-, y-, and z-parameters, which are other parameter sets used very often for specifying transistors at

Fig. 4. S parameters of 2N3478 transistor in common-emitter configuration, measured by $-hp-$ Model 8410A Network Analyzer. (a) s_{11} . Outermost circle on Smith Chart overlay corresponds to $|s_{11}| = 1$. (b) s_{22} . Scale factor same as (a). (c) s_{12} . (d) s_{21} . (e) s_{21} with line stretcher adjusted to remove linear phase shift above 500 MHz.

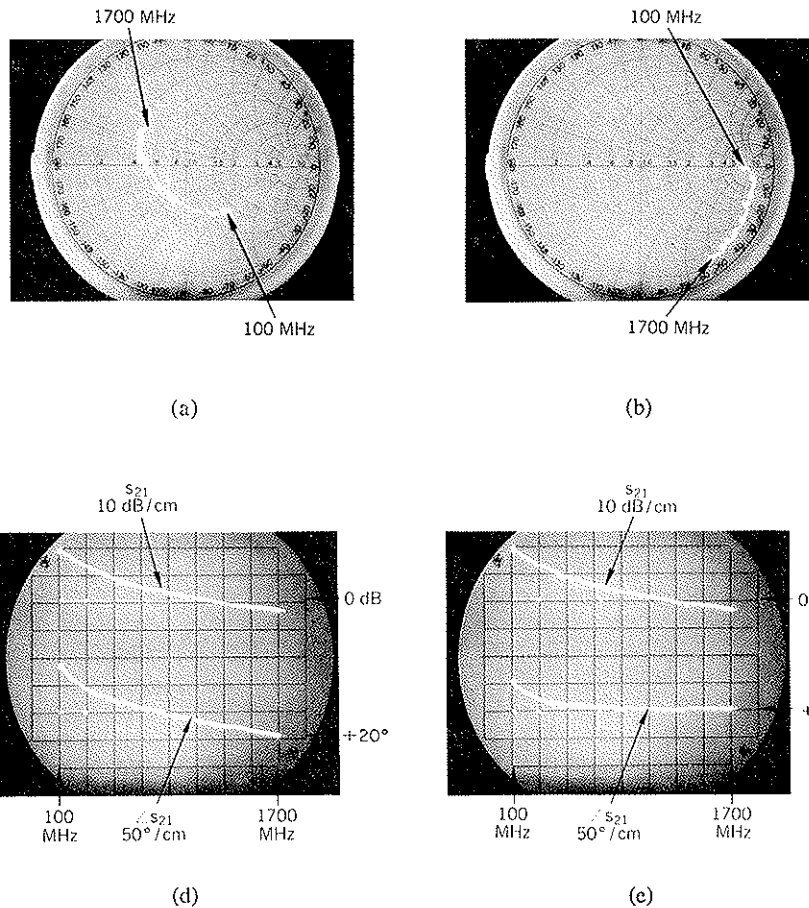

lower frequencies. Two important figures of merit used for comparing transistors, f_t and f_{max} , are also given, and their relationship to s -parameters is indicated.

Amplifier Design Using Scattering Parameters

The remainder of this article will show by several examples how s -parameters are used in the design of transistor amplifiers and oscillators. To keep the discussion from becoming bogged down in extraneous details, the emphasis in these examples will be on s -parameter design methods, and mathematical manipulations will be omitted wherever possible.

Measurement of S-Parameters

Most design problems will begin with a tentative selection of a device and the measurement of its s -parameters. Fig. 4 is a set of oscillograms containing complete s -parameter data for a 2N3478 transistor in the common-emitter configuration. These oscillograms are the results of swept-frequency measurements made with the new microwave network analyzer described elsewhere in this issue. They represent the actual s -parameters of this transistor between 100 MHz and 1700 MHz.

In Fig. 5, the magnitude of s_{21} from Fig. 4(d) is replotted on a logarithmic frequency scale, along with additional data on s_{21} below 100 MHz, measured with a vector voltmeter. The magnitude of s_{21} is essentially constant to 125 MHz, and then rolls off at a slope of 6 dB/octave. The phase angle

of s_{21} , as seen in Fig. 4(d), varies linearly with frequency above about 500 MHz. By adjusting a calibrated line stretcher in the network analyzer, a compensating linear phase shift was introduced, and the phase curve of Fig. 4(e) resulted. To go from the phase curve of Fig. 4(d) to that of Fig. 4(e) required 3.35 cm of line, equivalent to a pure time delay of 112 picoseconds.

After removal of the constant-delay, or linear-phase, component, the phase angle of s_{21} for this transistor [Fig. 4(e)] varies from 180° at dc to $+90^\circ$ at high frequencies, passing through $+135^\circ$ at 125 MHz, the -3 dB point of the magnitude curve. In other words, s_{21} behaves like a single pole in the frequency domain, and it is possible to write a closed expression for it. This expression is

$$s_{21} = \frac{-s_{210} e^{-j\omega T_0}}{1 + j\frac{\omega}{\omega_0}} \quad (21)$$

where

$$\begin{aligned} T_0 &= 112 \text{ ps} \\ \omega &= 2\pi f \\ \omega_0 &= 2\pi \times 125 \text{ MHz} \\ s_{210} &= 11.2 = 21 \text{ dB} \end{aligned}$$

The time delay $T_0 = 112$ ps is due primarily to the transit time of minority carriers (electrons) across the base of this npn transistor.

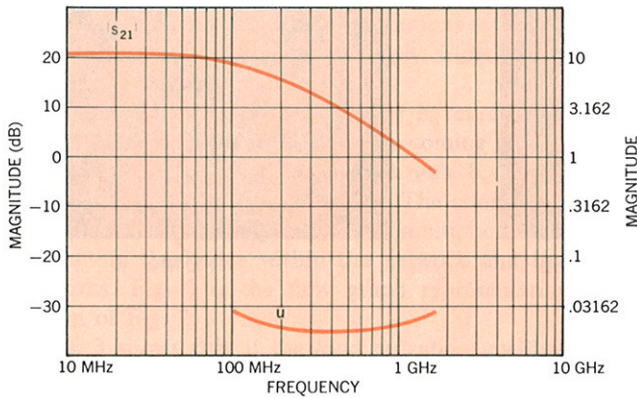

Fig. 5. Top curve: $|s_{21}|$ from Fig. 4 replotted on logarithmic frequency scale. Data below 100 MHz measured with $-hp-8405A$ Vector Voltmeter. Bottom curve: unilateral figure of merit, calculated from s parameters (see text).

Narrow-Band Amplifier Design

Suppose now that this 2N3478 transistor is to be used in a simple amplifier, operating between a 50Ω source and a 50Ω load, and optimized for power gain at 300 MHz by means of lossless input and output matching networks. Since reverse gain s_{12} for this transistor is quite small — 50 dB smaller than forward gain s_{21} , according to Fig. 4 — there is a possibility that it can be neglected. If this is so, the design problem will be much simpler, because setting s_{12} equal to zero will make the design equations much less complicated.

In determining how much error will be introduced by assuming $s_{12} = 0$, the first step is to calculate the unilateral figure of merit u , using the formula given in the table on p. 11, i.e.

$$u = \frac{|s_{11}s_{12}s_{21}s_{22}|}{|(1 - |s_{11}|^2)(1 - |s_{22}|^2)|} \quad (22)$$

A plot of u as a function of frequency, calculated from the measured parameters, appears in Fig. 5. Now if G_{Tu} is the transducer power gain with $s_{12} = 0$ and G_T is the actual transducer power gain, the maximum error introduced by using G_{Tu} instead of G_T is given by the following relationship:

$$\frac{1}{(1 + u)^2} < \frac{G_T}{G_{Tu}} < \frac{1}{(1 - u)^2} \quad (23)$$

From Fig. 5, the maximum value of u is about 0.03, so the maximum error in this case turns out to be about ± 0.25 dB at 100 MHz. This is small enough to justify the assumption that $s_{12} = 0$.

Incidentally, a small reverse gain, or feedback factor, s_{12} , is an important and desirable property for a transistor to have, for reasons other than that it simplifies amplifier de-

sign. A small feedback factor means that the input characteristics of the completed amplifier will be independent of the load, and the output will be independent of the source impedance. In most amplifiers, isolation of source and load is an important consideration.

Returning now to the amplifier design, the unilateral expression for transducer power gain, obtained either by setting $s_{12} = 0$ in equation 18 or by looking in the table on p. 11, is

$$G_{Tu} = \frac{|s_{21}|^2(1 - |\Gamma_s|^2)(1 - |\Gamma_L|^2)}{|1 - s_{11}\Gamma_s|^2|1 - s_{22}\Gamma_L|^2} \quad (24)$$

When $|s_{11}|$ and $|s_{22}|$ are both less than one, as they are in this case, maximum G_{Tu} occurs for $\Gamma_s = s_{11}^*$ and $\Gamma_L = s_{22}^*$ (table, p. 11).

The next step in the design is to synthesize matching networks which will transform the 50Ω load and source impedances to the impedances corresponding to reflection coefficients of s_{11}^* and s_{22}^* , respectively. Since this is to be a single-frequency amplifier, the matching networks need not be complicated. Simple series-capacitor, shunt-inductor networks will not only do the job, but will also provide a handy means of biasing the transistor — via the inductor — and of isolating the dc bias from the load and source.

Values of L and C to be used in the matching networks are determined using the Smith Chart of Fig. 6. First, points corresponding to s_{11} , s_{11}^* , s_{22} , and s_{22}^* at 300 MHz are plotted. Each point represents the tip of a vector leading away from the center of the chart, its length equal to the magnitude of the reflection coefficient being plotted, and its angle equal to the phase of the coefficient. Next, a combination of constant-resistance and constant-conductance circles is found, leading from the center of the chart, representing 50Ω , to s_{11}^* and s_{22}^* . The circles on the Smith Chart are constant-resistance circles; increasing series capacitive reactance moves an impedance point counter-clockwise along these circles. In this case, the circle to be used for finding series C is the one passing through the center of the chart, as shown by the solid line in Fig. 6.

Increasing shunt inductive susceptance moves impedance points clockwise along constant-conductance circles. These circles are like the constant-resistance circles, but they are on another Smith Chart, this one being just the reverse of the one in Fig. 6. The constant-conductance circles for shunt L all pass through the leftmost point of the chart rather than the rightmost point. The circles to be used are those passing through s_{11}^* and s_{22}^* , as shown by the dashed lines in Fig. 6.

Once these circles have been located, the normalized values of L and C needed for the matching networks are calculated from readings taken from the reactance and susceptance scales of the Smith Charts. Each element's reactance or susceptance is the difference between the scale readings at the two end points of a circular arc. Which arc corresponds to which element is indicated in Fig. 6. The final network and the element values, normalized and unnormalized, are shown in Fig. 7.

Broadband Amplifier Design

Designing a broadband amplifier, that is, one which has nearly constant gain over a prescribed frequency range, is a matter of surrounding a transistor with external elements in order to compensate for the variation of forward gain $|s_{21}|$ with frequency. This can be done in either of two ways—first, negative feedback, or second, selective mismatching of the input and output circuitry. We will use the second method. When feedback is used, it is usually convenient to convert to y- or z-parameters (for shunt or series feedback respectively) using the conversion equations given in the table, p. 12, and a digital computer.

Equation 24 for the unilateral transducer power gain can be factored into three parts:

$$G_{Tu} = G_o G_1 G_2$$

where

$$G_o = |s_{21}|^2$$

$$G_1 = \frac{1 - |\Gamma_s|^2}{|1 - s_{11}\Gamma_s|^2}$$

$$G_2 = \frac{1 - |\Gamma_L|^2}{|1 - s_{22}\Gamma_L|^2}$$

When a broadband amplifier is designed by selective mismatching, the gain contributions of G_1 and G_2 are varied to compensate for the variations of $G_o = |s_{21}|^2$ with frequency.

Suppose that the 2N3478 transistor whose s-parameters are given in Fig. 4 is to be used in a broadband amplifier which has a constant gain of 10 dB over a frequency range of 300 MHz to 700 MHz. The amplifier is to be driven from a 50Ω source and is to drive a 50Ω load. According to Fig. 5,

$$\begin{aligned} |s_{21}|^2 &= 13 \text{ dB at } 300 \text{ MHz} \\ &= 10 \text{ dB at } 450 \text{ MHz} \\ &= 6 \text{ dB at } 700 \text{ MHz} . \end{aligned}$$

To realize an amplifier with a constant gain of 10 dB, source and load matching networks must be found which will decrease the gain by 3 dB at 300 MHz, leave the gain the same at 450 MHz, and increase the gain by 4 dB at 700 MHz.

Although in the general case both a source matching network and a load matching network would be designed, $G_{1\max}$ (i.e., G_1 for $\Gamma_s = s_{11}^*$) for this transistor is less than 1 dB over the frequencies of interest, which means there is little to be gained by matching the source. Consequently, for this example, only a load-matching network will be designed. Procedures for designing source-matching networks are identical to those used for designing load-matching networks.

The first step in the design is to plot s_{22}^* over the required frequency range on the Smith Chart, Fig. 8. Next, a set of constant-gain circles is drawn. Each circle is drawn for a single frequency; its center is on a line between the center of the Smith Chart and the point representing s_{22}^* at that frequency. The distance from the center of the Smith Chart to the center of the constant gain circle is given by (these equations also appear in the table, p. 11):

$$r_2 = \frac{g_2 |s_{22}|}{1 - |s_{22}|^2 (1 - g_2)}$$

where

$$g_2 = \frac{G_2}{G_{2\max}} = G_2 (1 - |s_{22}|^2)$$

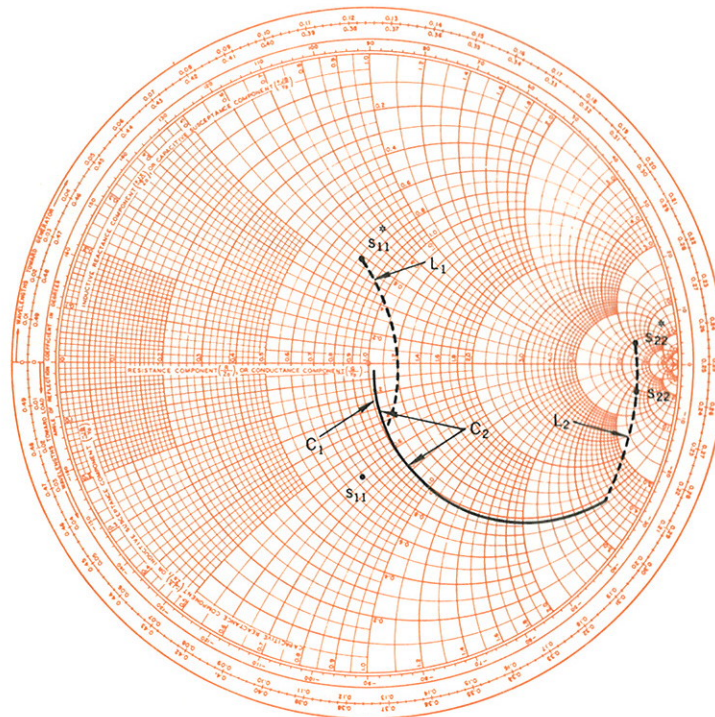

Fig. 6. Smith Chart for 300-MHz amplifier design example.

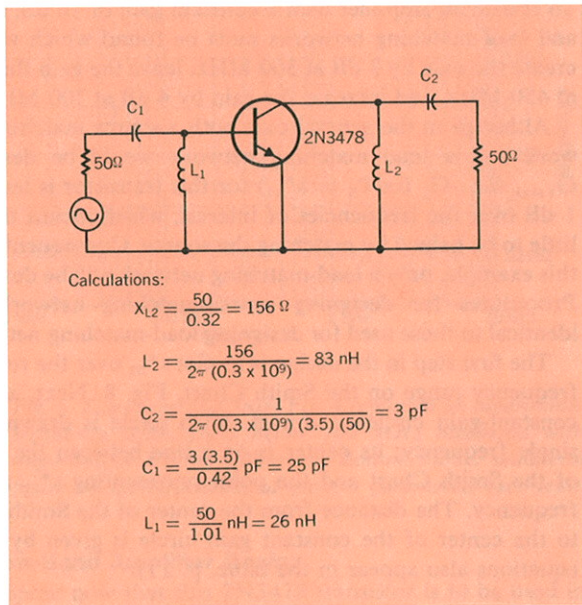

Fig. 7. 300-MHz amplifier with matching networks for maximum power gain.

The radius of the constant-gain circle is

$$\rho_2 = \frac{\sqrt{1 - g_2} (1 - |s_{22}|^2)}{1 - |s_{22}|^2 (1 - g_2)}$$

For this example, three circles will be drawn, one for $G_2 = -3$ dB at 300 MHz, one for $G_2 = 0$ dB at 450 MHz, and one for $G_2 = +4$ dB at 700 MHz. Since $|s_{22}|$ for this transistor is constant at 0.85 over the frequency range [see Fig. 4(b)], $G_{2 \text{ max}}$ for all three circles is $(0.278)^{-1}$, or 5.6 dB. The three constant-gain circles are indicated in Fig. 8.

The required matching network must transform the center of the Smith Chart, representing 50Ω , to some point on the -3 dB circle at 300 MHz, to some point on the 0 dB circle at 450 MHz, and to some point on the $+4$ dB circle at 700 MHz. There are undoubtedly many networks that will do this. One which is satisfactory is a combination of two inductors, one in shunt and one in series, as shown in Fig. 9.

Shunt and series elements move impedance points on the Smith Chart along constant-conductance and constant-resistance circles, as I explained in the narrow-band design example which preceded this broadband design example. The shunt inductance transforms the 50Ω load along a circle of constant conductance and varying (with frequency) inductive susceptance. The series inductor transforms the combination of the 50Ω load and the shunt inductance along circles of constant resistance and varying inductive reactance.

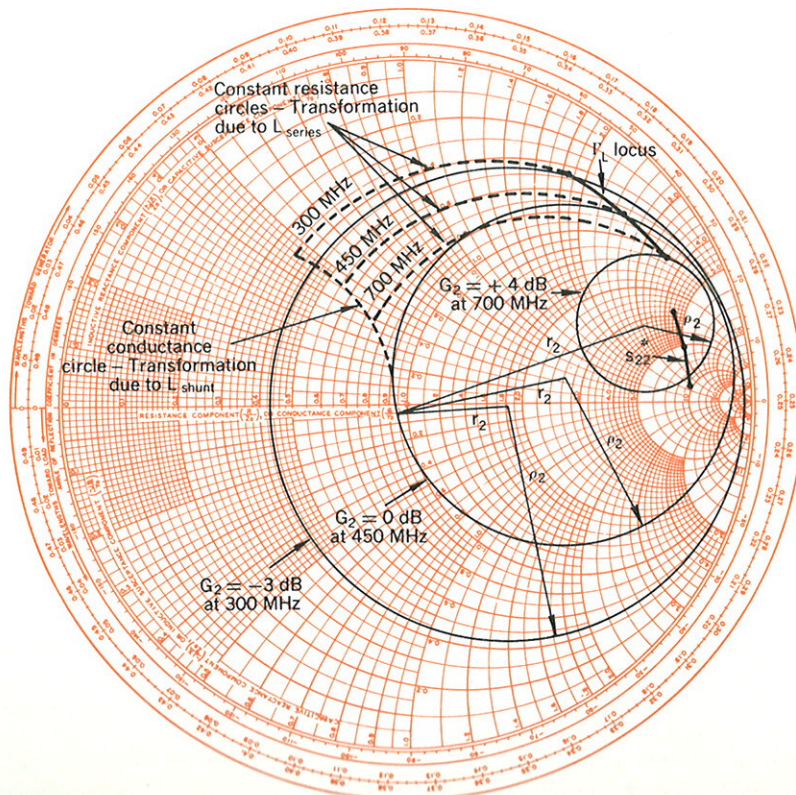

Fig. 8. Smith Chart for broadband amplifier design example.

Optimizing the values of shunt and series L is a cut-and-try process to adjust these elements so that

- the transformed load reflection terminates on the right gain circle at each frequency, and
- the susceptance component decreases with frequency and the reactance component increases with frequency. (This rule applies to inductors; capacitors would behave in the opposite way.)

Once appropriate constant-conductance and constant-resistance circles have been found, the reactances and susceptances of the elements can be read directly from the Smith Chart. Then the element values are calculated, the same as they were for the narrow-band design.

Fig. 10 is a schematic diagram of the completed broadband amplifier, with unnormalized element values.

Stability Considerations and the Design of Reflection Amplifiers and Oscillators

When the real part of the input impedance of a network is negative, the corresponding input reflection coefficient (equation 17) is greater than one, and the network can be used as the basis for two important types of circuits, reflection amplifiers and oscillators. A reflection amplifier (Fig. 11) can be realized with a circulator—a nonreciprocal three-port device—and a negative-resistance device. The circulator is used to separate the incident (input) wave from the larger wave reflected by the negative-resistance device. Theoretically, if the circulator is perfect and has a positive real characteristic impedance Z_0 , an amplifier with infinite gain can be built by selecting a negative-resistance device whose input impedance has a real part equal to $-Z_0$ and an imaginary part equal to zero (the imaginary part can be set equal to zero by tuning, if necessary).

Amplifiers, of course, are not supposed to oscillate, whether they are reflection amplifiers or some other kind. There is a convenient criterion based upon scattering parameters for determining whether a device is stable or potentially unstable with given source and load impedances. Referring again to the flow graph of Fig. 3, the ratio of the reflected voltage wave b_1 to the input voltage wave b_s is

$$\frac{b_1}{b_s} = \frac{s'_{11}}{1 - \Gamma_s s'_{11}}$$

where s'_{11} is the input reflection coefficient with $\Gamma_s = 0$ (that is, $Z_s = Z_0$) and an arbitrary load impedance Z_L , as defined in equation 19.

If at some frequency

$$\Gamma_s s'_{11} = 1 \quad (25)$$

the circuit is unstable and will oscillate at that frequency. On the other hand, if

$$|s'_{11}| < \left| \frac{1}{\Gamma_s} \right|$$

the device is unconditionally stable and will not oscillate, whatever the phase angle of Γ_s might be.

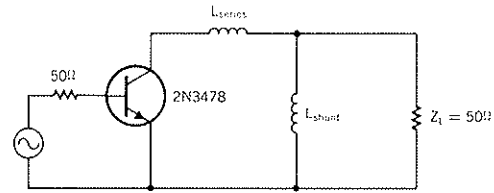
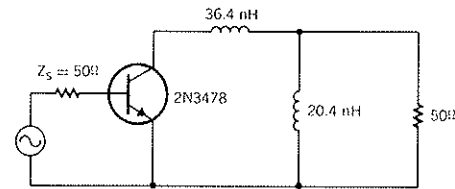

Fig. 9. Combination of shunt and series inductances is suitable matching network for broadband amplifier.



Inductance calculations:

$$\text{From 700 MHz data, } \frac{j^2 L_{\text{series}}}{Z_0} = j(3.64 - 0.44) = j3.2$$

$$L_{\text{series}} = \frac{(3.2)(50)}{2\pi(0.7)} \text{ nH} = 36.4 \text{ nH}$$

$$\text{From 300 MHz data, } \frac{Z_0}{j^2 L_{\text{shunt}}} = -j1.3$$

$$L_{\text{shunt}} = \frac{50}{(1.3)(2\pi)(0.3)} = 20.4 \text{ nH}$$

Fig. 10. Broadband amplifier with constant gain of 10 dB from 300 MHz to 700 MHz.

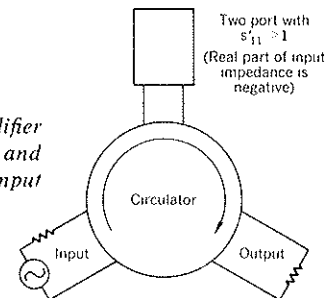

Fig. 11. Reflection amplifier consists of circulator and transistor with negative input resistance.

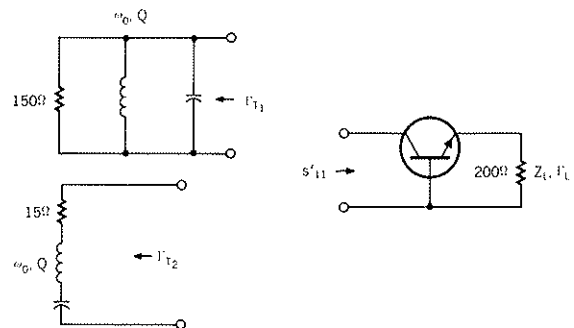

Fig. 12. Transistor oscillator is designed by choosing tank circuit such that $\Gamma_T s'_{11} = 1$.

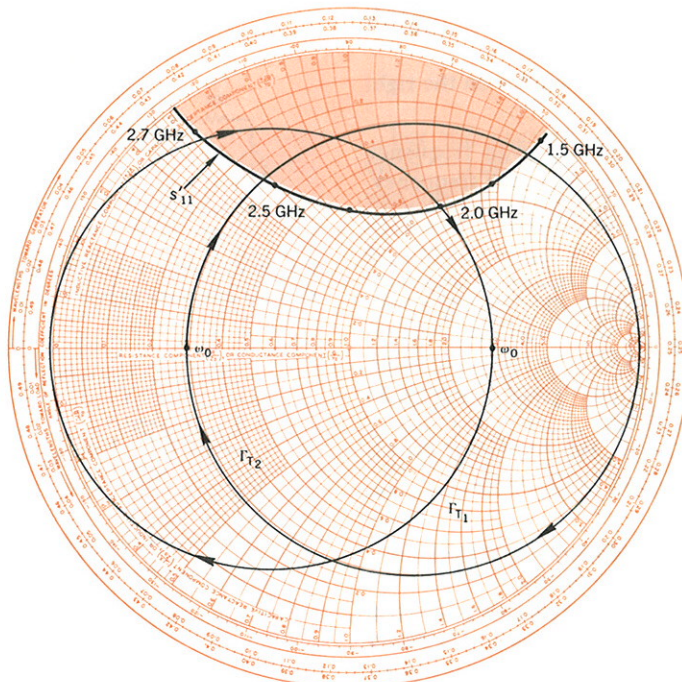

Fig. 13. Smith Chart for transistor oscillator design example.

As an example of how these principles of stability are applied in design problems, consider the transistor oscillator design illustrated in Fig. 12. In this case the input reflection coefficient s'_{11} is the reflection coefficient looking into the collector circuit, and the 'source' reflection coefficient Γ_s is one of the two tank-circuit reflection coefficients, Γ_{T1} or Γ_{T2} . From equation 19,

$$s'_{11} = s_{11} + \frac{s_{12} s_{21} \Gamma_L}{1 - s_{22} \Gamma_L}$$

To make the transistor oscillate, s'_{11} and Γ_s must be adjusted so that they satisfy equation 25. There are four steps in the design procedure:

- Measure the four scattering parameters of the transistor as functions of frequency.
- Choose a load reflection coefficient Γ_L which makes s'_{11} greater than unity. In general, it may also take an external feedback element which increases $s_{12} s_{21}$ to make s'_{11} greater than one.
- Plot $1/s'_{11}$ on a Smith Chart. (If the new network analyzer is being used to measure the s-parameters of the transistor, $1/s'_{11}$ can be measured directly by reversing the reference and test channel connections between the reflection test unit and the harmonic frequency converter. The polar display with a Smith Chart overlay will then give the desired plot immediately.)
- Connect either the series or the parallel tank circuit to the collector circuit and tune it so that Γ_{T1} or Γ_{T2} is large enough to satisfy equation 25 (the tank circuit reflection coefficient plays the role of Γ_s in this equation).

Fig. 13 shows a Smith Chart plot of $1/s'_{11}$ for a high-frequency transistor in the common-base configuration. Load impedance Z_L is 200Ω , which means that Γ_L referred to 50Ω is 0.6. Reflection coefficients Γ_{T1} and Γ_{T2} are also plotted as functions of the resonant frequencies of the two tank circuits. Oscillations occur when the locus of Γ_{T1} or Γ_{T2} passes through the shaded region. Thus this transistor would oscillate from 1.5 to 2.5 GHz with a series tuned circuit and from 2.0 to 2.7 GHz with a parallel tuned circuit.

—Richard W. Anderson

Additional Reading on S-Parameters

Besides the papers referenced in the footnotes of the article, the following articles and books contain information on s-parameter design procedures and flow graphs.

- F. Weinert, 'Scattering Parameters Speed Design of High-Frequency Transistor Circuits', *Electronics*, Vol. 39, No. 18, Sept. 5, 1966.
- G. Fredricks, 'How to Use S-Parameters for Transistor Circuit Design', *EEE*, Vol. 14, No. 12, Dec., 1966.
- D. C. Youla, 'On Scattering Matrices Normalized to Complex Port Numbers', *Proc. IRE*, Vol. 49, No. 7, July, 1961.
- J. G. Linvill and J. F. Gibbons, 'Transistors and Active Circuits', McGraw-Hill, 1961. (No s-parameters, but good treatment of Smith Chart design methods.)

Useful Scattering Parameter Relationships

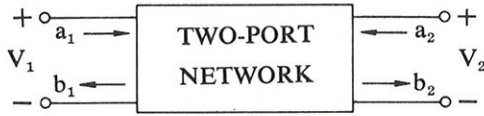

$$b_1 = s_{11}a_1 + s_{12}a_2$$

$$b_2 = s_{21}a_1 + s_{22}a_2$$

Input reflection coefficient with arbitrary Z_L

$$s'_{11} = s_{11} + \frac{s_{12}s_{21}\Gamma_L}{1 - s_{22}\Gamma_L}$$

Output reflection coefficient with arbitrary Z_S

$$s'_{22} = s_{22} + \frac{s_{12}s_{21}\Gamma_S}{1 - s_{11}\Gamma_S}$$

Voltage gain with arbitrary Z_L and Z_S

$$A_V = \frac{V_2}{V_1} = \frac{s_{21}(1 + \Gamma_L)}{(1 - s_{22}\Gamma_L)(1 + s'_{11})}$$

Power Gain = $\frac{\text{Power delivered to load}}{\text{Power input to network}}$

$$G = \frac{|s_{21}|^2(1 - |\Gamma_L|^2)}{(1 - |s_{11}|^2) + |\Gamma_L|^2(|s_{22}|^2 - |D|^2) - 2 \operatorname{Re}(\Gamma_L N)}$$

Available Power Gain = $\frac{\text{Power available from network}}{\text{Power available from source}}$

$$G_A = \frac{|s_{21}|^2(1 - |\Gamma_S|^2)}{(1 - |s_{22}|^2) + |\Gamma_S|^2(|s_{11}|^2 - |D|^2) - 2 \operatorname{Re}(\Gamma_S M)}$$

Transducer Power Gain = $\frac{\text{Power delivered to load}}{\text{Power available from source}}$

$$G_T = \frac{|s_{21}|^2(1 - |\Gamma_S|^2)(1 - |\Gamma_L|^2)}{[(1 - s_{11}\Gamma_S)(1 - s_{22}\Gamma_L) - s_{12}s_{21}\Gamma_L\Gamma_S]^2}$$

Unilateral Transducer Power Gain ($s_{12} = 0$)

$$G_{Tu} = \frac{|s_{21}|^2(1 - |\Gamma_S|^2)(1 - |\Gamma_L|^2)}{|1 - s_{11}\Gamma_S|^2 |1 - s_{22}\Gamma_L|^2}$$

$$= G_0 G_1 G_2$$

$$G_0 = |s_{21}|^2$$

$$G_1 = \frac{1 - |\Gamma_S|^2}{|1 - s_{11}\Gamma_S|^2}$$

$$G_2 = \frac{1 - |\Gamma_L|^2}{|1 - s_{22}\Gamma_L|^2}$$

Maximum Unilateral Transducer Power Gain when $|s_{11}| < 1$ and $|s_{22}| < 1$

$$G_u = \frac{|s_{21}|^2}{|(1 - |s_{11}|^2)(1 - |s_{22}|^2)|}$$

$$= G_0 G_{1 \max} G_{2 \max}$$

$$G_{i \max} = \frac{1}{1 - |s_{ii}|^2} \quad i = 1, 2$$

This maximum attained for $\Gamma_S = s_{11}^*$ and $\Gamma_L = s_{22}^*$

Constant Gain Circles (Unilateral case: $s_{12} = 0$)

—center of constant gain circle is on line between center of Smith Chart and point representing s_{11}^*

—distance of center of circle from center of Smith Chart:

$$r_i = \frac{g_i |s_{ii}|}{1 - |s_{ii}|^2 (1 - g_i)}$$

—radius of circle:

$$\rho_i = \frac{\sqrt{1 - g_i}(1 - |s_{ii}|^2)}{1 - |s_{ii}|^2 (1 - g_i)}$$

where: $i = 1, 2$

$$\text{and } g_i = \frac{G_i}{G_{i \max}} = G_i (1 - |s_{ii}|^2)$$

Unilateral Figure of Merit

$$u = \frac{|s_{11}s_{22}s_{12}s_{21}|}{|(1 - |s_{11}|^2)(1 - |s_{22}|^2)|}$$

Error Limits on Unilateral Gain Calculation

$$\frac{1}{(1 + u^2)} < \frac{G_T}{G_{Tu}} < \frac{1}{(1 - u^2)}$$

Conditions for Absolute Stability

No passive source or load will cause network to oscillate if a, b, and c are all satisfied.

- a. $|s_{11}| < 1, |s_{22}| < 1$
- b. $\left| \frac{|s_{12}s_{21}| - |M^*|}{|s_{11}|^2 - |D|^2} \right| > 1$
- c. $\left| \frac{|s_{12}s_{21}| - |N^*|}{|s_{22}|^2 - |D|^2} \right| > 1$

Condition that a two-port network can be simultaneously matched with a positive real source and load:

$K > 1$ or $C < 1$
 $C = \text{Linville C factor}$

Linville C Factor

$C = K^{-1}$

$$K = \frac{1 + |D|^2 - |s_{11}|^2 - |s_{22}|^2}{2 |s_{12}s_{21}|}$$

Source and Load for Simultaneous Match

$$\Gamma_{mS} = M^* \left[\frac{B_1 \pm \sqrt{B_1^2 - 4|M|^2}}{2|M|^2} \right]$$

$$\Gamma_{mL} = N^* \left[\frac{B_2 \pm \sqrt{B_2^2 - 4|N|^2}}{2|N|^2} \right]$$

Where $B_1 = 1 + |s_{11}|^2 - |s_{22}|^2 - |D|^2$
 $B_2 = 1 + |s_{22}|^2 - |s_{11}|^2 - |D|^2$

Maximum Available Power Gain

If $K > 1$,

$$G_{A \max} = \left| \frac{s_{21}}{s_{12}} (K \pm \sqrt{K^2 - 1}) \right|$$

 $C = K^{-1}$
 $C = \text{Linville C Factor}$

(Use minus sign when B_1 is positive, plus sign when B_1 is negative. For definition of B_1 see 'Source and Load for Simultaneous Match,' elsewhere in this table.)

$$D = s_{11}s_{22} - s_{12}s_{21}$$

$$M = s_{11} - D s_{22}^*$$

$$N = s_{22} - D s_{11}^*$$

s-parameters in terms of h-, y-, and z-parameters	h-, y-, and z-parameters in terms of s-parameters
$s_{11} = \frac{(z_{11} - 1)(z_{22} + 1) - z_{12}z_{21}}{(z_{11} + 1)(z_{22} + 1) - z_{12}z_{21}}$	$z_{11} = \frac{(1 + s_{11})(1 - s_{22}) + s_{12}s_{21}}{(1 - s_{11})(1 - s_{22}) - s_{12}s_{21}}$
$s_{12} = \frac{2z_{12}}{(z_{11} + 1)(z_{22} + 1) - z_{12}z_{21}}$	$z_{12} = \frac{2s_{12}}{(1 - s_{11})(1 - s_{22}) - s_{12}s_{21}}$
$s_{21} = \frac{2z_{21}}{(z_{11} + 1)(z_{22} + 1) - z_{12}z_{21}}$	$z_{21} = \frac{2s_{21}}{(1 - s_{11})(1 - s_{22}) - s_{12}s_{21}}$
$s_{22} = \frac{(z_{11} + 1)(z_{22} - 1) - z_{12}z_{21}}{(z_{11} + 1)(z_{22} + 1) - z_{12}z_{21}}$	$z_{22} = \frac{(1 + s_{22})(1 - s_{11}) + s_{12}s_{21}}{(1 - s_{11})(1 - s_{22}) - s_{12}s_{21}}$
$s_{11} = \frac{(1 - y_{11})(1 + y_{22}) + y_{12}y_{21}}{(1 + y_{11})(1 + y_{22}) - y_{12}y_{21}}$	$y_{11} = \frac{(1 + s_{22})(1 - s_{11}) + s_{12}s_{21}}{(1 + s_{11})(1 + s_{22}) - s_{12}s_{21}}$
$s_{12} = \frac{-2y_{12}}{(1 + y_{11})(1 + y_{22}) - y_{12}y_{21}}$	$y_{12} = \frac{-2s_{12}}{(1 + s_{11})(1 + s_{22}) - s_{12}s_{21}}$
$s_{21} = \frac{-2y_{21}}{(1 + y_{11})(1 + y_{22}) - y_{12}y_{21}}$	$y_{21} = \frac{-2s_{21}}{(1 + s_{11})(1 + s_{22}) - s_{12}s_{21}}$
$s_{22} = \frac{(1 + y_{11})(1 - y_{22}) + y_{12}y_{21}}{(1 + y_{11})(1 + y_{22}) - y_{12}y_{21}}$	$y_{22} = \frac{(1 + s_{11})(1 - s_{22}) + s_{12}s_{21}}{(1 + s_{22})(1 + s_{11}) - s_{12}s_{21}}$
$s_{11} = \frac{(h_{11} - 1)(h_{22} + 1) - h_{12}h_{21}}{(h_{11} + 1)(h_{22} + 1) - h_{12}h_{21}}$	$h_{11} = \frac{(1 + s_{11})(1 + s_{22}) - s_{12}s_{21}}{(1 - s_{11})(1 + s_{22}) + s_{12}s_{21}}$
$s_{12} = \frac{2h_{12}}{(h_{11} + 1)(h_{22} + 1) - h_{12}h_{21}}$	$h_{12} = \frac{2s_{12}}{(1 - s_{11})(1 + s_{22}) + s_{12}s_{21}}$
$s_{21} = \frac{-2h_{21}}{(h_{11} + 1)(h_{22} + 1) - h_{12}h_{21}}$	$h_{21} = \frac{-2s_{21}}{(1 - s_{11})(1 + s_{22}) + s_{12}s_{21}}$
$s_{22} = \frac{(1 + h_{11})(1 - h_{22}) + h_{12}h_{21}}{(h_{11} + 1)(h_{22} + 1) - h_{12}h_{21}}$	$h_{22} = \frac{(1 - s_{22})(1 - s_{11}) - s_{12}s_{21}}{(1 - s_{11})(1 + s_{22}) + s_{12}s_{21}}$

The h-, y-, and z-parameters listed above are all normalized to Z_0 . If h' , y' , and z' are the actual parameters, then

$z_{11}' = z_{11}Z_0$	$y_{11}' = \frac{y_{11}}{Z_0}$	$h_{11}' = h_{11}Z_0$
$z_{12}' = z_{12}Z_0$	$y_{12}' = \frac{y_{12}}{Z_0}$	$h_{12}' = h_{12}$
$z_{21}' = z_{21}Z_0$	$y_{21}' = \frac{y_{21}}{Z_0}$	$h_{21}' = h_{21}$
$z_{22}' = z_{22}Z_0$	$y_{22}' = \frac{y_{22}}{Z_0}$	$h_{22}' = \frac{h_{22}}{Z_0}$

Reprinted Compliments of
 Hewlett-Packard Journal
 Vol. 18, No. 6 FEB 1967